











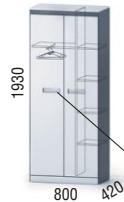



regaly wysokie

regaly posiadają tyły z płyty 18 mm • brak zamków w standardzie

 WGR1 659,- netto	 WGR2 787,- netto	 WGR3 894,- netto	 WGR4 937,- netto
 WGR6 572,- netto	 WGR7 682,- netto	 WGR8 774,- netto	 WGR9 drzwi z matowego szkła 946,- netto

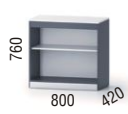
regaly niskie

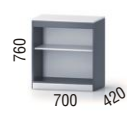



regaly posiadają tyły z płyty 18 mm • brak zamków w standardzie

 WGR11 527,- netto	 WGR12 629,- netto	 WGR13 715,- netto	 WGR14 drzwi z matowego szkła 830,- netto
 WGR16 483,- netto	 WGR17 656,- netto	 WGR18 440,- netto	 WGR19 596,- netto

regaly żaluzjowe i przesuwne

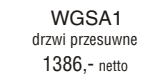
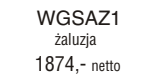
regaly posiadają tyły z płyty HDF 3 mm

• zamek w standardzie

 WGSZA1 drzwi przesuwne 1386,- netto	 WGSZA2 żaluzja 1874,- netto	 WGSZA3 żaluzja 1874,- netto
 WGSZA4 drzwi przesuwne 1386,- netto	 WGSZA5 żaluzja 1874,- netto	 WGSZA6 żaluzja 1874,- netto

dostawki

brak zamków w standardzie

 WGD1 1869,- netto	 WGD2 1845,- netto	 WGD3 1990,- netto	 WGD4 1966,- netto
--	---	---	---

nadstawki





stoły

grubość blatów 18 mm, opcja 25 mm - 10% dopłaty

możliwości kolorystyczne blatów i stelaży

 WGZ0 nadstawka z możliwością zawieszenia na ścianę 720,- netto	 WGN1 502,- netto	 WGN2 645,- netto
--	--	--

opcje wyboru zamków:

 ZB zamek baswilowy firmy Lehman dopłata 135,- netto	 ZP zamek patentowy dopłata 55,- netto	 ZZ zamek żaluzjowy dopłata 75,- netto	 PK zamek punktowy dopłata 55,- netto
--	---	--	---

kontenery

standard:

 WGK1 kontener z piórnikiem, cichy domek 1050,- netto	 WGK2 cichy domek 962,- netto	 WGK3 cichy domek 934,- netto	 WGK4 745,- netto
---	--	---	--

opcja:

 K1
dopłata 150,- netto / 4 szt.

opcja:

 K2
dopłata 250,- netto / 4 szt.

brak zamków w standardzie

pomocniki

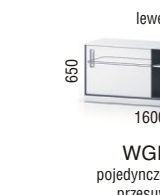
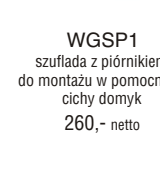
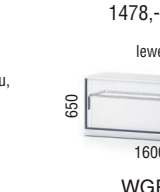
 WGP1 pojedyncze drzwi przesuwne 1478,- netto	 WGP2 pojedyncze drzwi przesuwne 1478,- netto
 WGP3 pomocnik z żaluzją 1805,- netto	 WGP4 pomocnik z żaluzją 1805,- netto

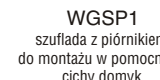
WGSP1
szuflada z piórnikiem do montażu w pomocniku, cichy domek
260,- netto

przegrody

uchwyty montażowe w komplecie

 WGA1 dwustronnie tapicerowana 399,- netto	 WGA2 dwustronnie tapicerowana 410,- netto	 WGA3 dwustronnie tapicerowana 470,- netto	 WGA4 dwustronnie tapicerowana 480,- netto	 WGA5 dwustronnie tapicerowana 520,- netto
--	--	--	--	--



maskownice biur

 WGL1 maskownica do biurka 1200 mm 262,- netto	 WGL2 maskownica do biurka 1400 mm 299,- netto	 WGL3 maskownica do biurka 1600 mm 336,- netto
--	--	--





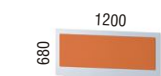





kolory tapicerek firmy PROFIM

przegrody z podcięciami

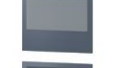
do podwójnych stanowisk

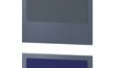
 WGA12 dwustronnie tapicerowana 515,- netto	 WGA13 dwustronnie tapicerowana 538,- netto	 WGA14 dwustronnie tapicerowana 571,- netto
---	---	---





możliwości kolorystyczne przegród

		NX-3
		NX-9
		NX-10
		NX-14
		NX-15

biurka

grubość blatów 18 mm, opcja 25 mm - 10% dopłaty

 WGS1 585,- netto	 WGS2 702,- netto	 WGS3 1102,- netto
--	--	---

 WGB2-7 528,- netto	 WGB2-8 590,- netto	 WGB3-7 566,- netto	 WGB3-8 631,- netto	 WGB4-7 600,- netto	 WGB4-8 671,- netto
--	--	--	--	--	--





podwójne stanowiska

 WGB12 1038,- netto	 WGB13 1115,- netto	 WGB14 1174,- netto
--	--	--

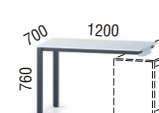

grubość blatów 18 mm, opcja 25 mm - 10% dopłaty

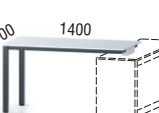
biurka nakładane

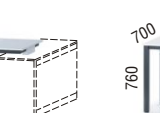
 Szyna z regulacją głębokości biurka względem pomocnika

 WGBN2-7 535,- netto	 WGBN2-8 597,- netto	 WGBN3-7 572,- netto	 WGBN3-8 638,- netto	 WGBN4-7 606,- netto	 WGBN4-8 678,- netto
--	--	--	--	--	--

podwójne stanowiska

 WGBN12 1056,- netto	 WGBN13 1123,- netto	 WGBN14 1186,- netto
---	---	---